

ROHS REACH

日期版次	日期	变更内容	核 准
REVISION	DATE	DESCRIPTION	APPROVALBY

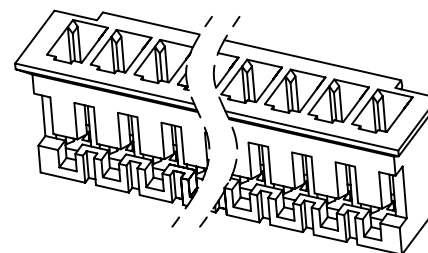
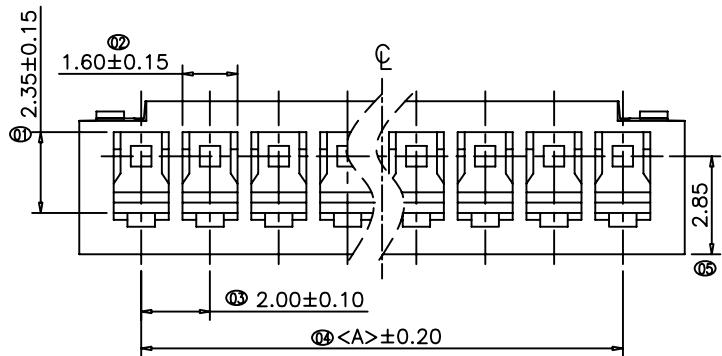

SPECIFICATIONS

- Voltage rating: 200V DC/AC (rms)
- Current rating: 1.0A
- Withstand voltage: 500V AC(rms)
- Working Temperature: -25℃+85℃
- Insulation resistance: ≥1000MΩ
- Contact resistance: ≤20MΩ

HOUSING

- PART NO: A2017H
- MATERIAL: PA66 94V-0
- COLOR: BROWN
- USE WITH:
 - Terminal: A2017T
 - Wafer: A2017R A2017V
- Q'TY: 1000PCS/BAG

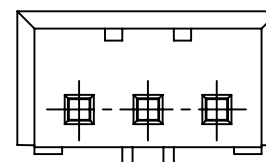
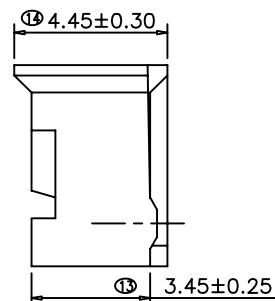
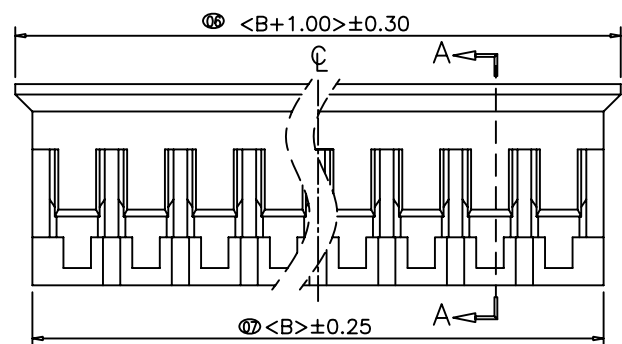

3P示意图

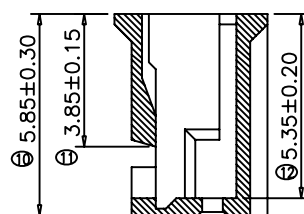
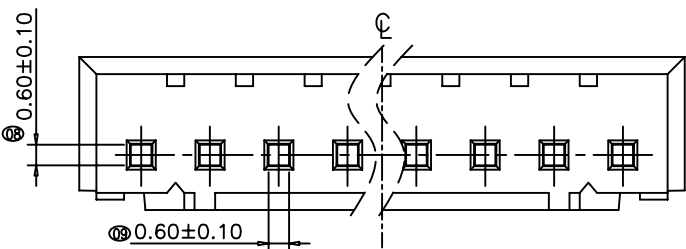

SECTION: (A-A)

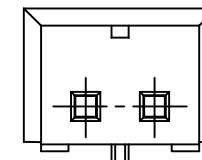

2P示意图

poles	part no.	dimensions (mm)	
		A	B
2	A2017H-2P	2.00	4.60
3	A2017H-3P	4.00	6.60
4	A2017H-4P	6.00	8.60
5	A2017H-5P	8.00	10.60
6	A2017H-6P	10.00	12.60
7	A2017H-7P	12.00	14.60
8	A2017H-8P	14.00	16.60
9	A2017H-9P	16.00	18.60
10	A2017H-10P	18.00	20.60
11	A2017H-11P	20.00	22.60
12	A2017H-12P	22.00	24.60
13	A2017H-13P	24.00	26.60
14	A2017H-14P	26.00	28.60
15	A2017H-15P	28.00	30.60
16	A2017H-16P	30.00	32.60

REV: A	APPROVE	CHECK	DRAWN
SHEET: 1/1	FENG	ZENG	LIJIAN

MATERIAL:	GENERAL TOLERANCE	
UNIT: MM	X. ±0.30	X.* ±2°
SCALE: 3:1	X.X ±0.25	X.X* ±1°
SIZE: A4	X.XX ±0.15	⊕ ⊖

YSTZ 东莞市轩盟电子科技有限公司
 DONGGUAN YSTZ ELECTRONIC TECHNOLOGY CO.,LTD

PART NO: A2017H-NP-14E-01
 TITLE: JAE2.00MM PITCH HOUSING

ROHS REACH

日期版次 REVISION	日期 DATE	变更内容 DESCRIPTION	核 准 APPROVALBY

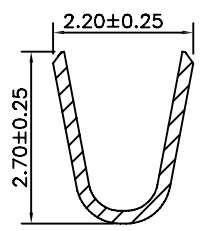
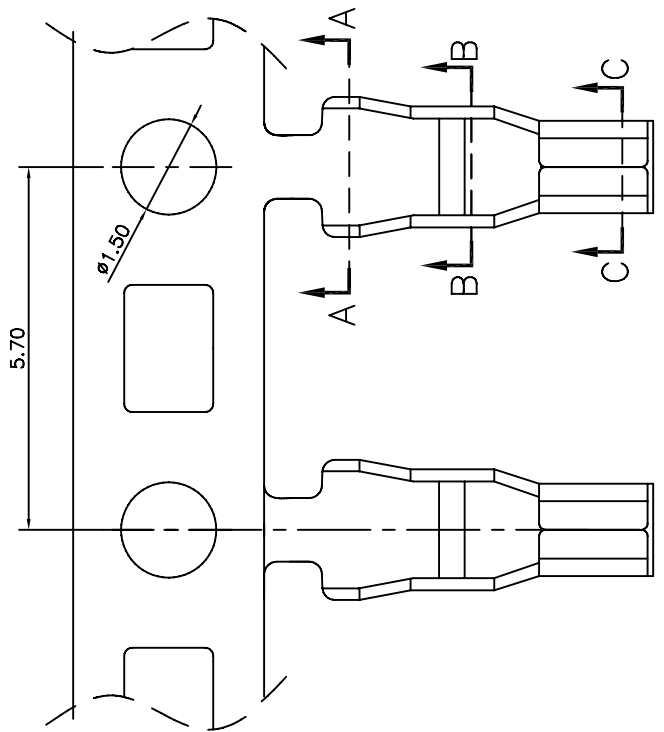

SECTION:A-A

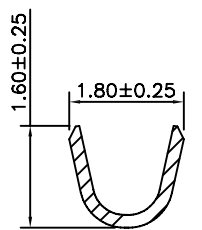

SECTION:B-B

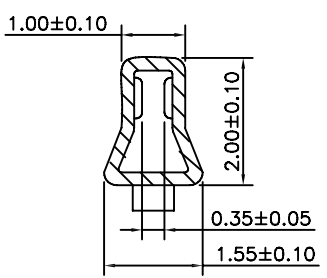

SECTION:C-C

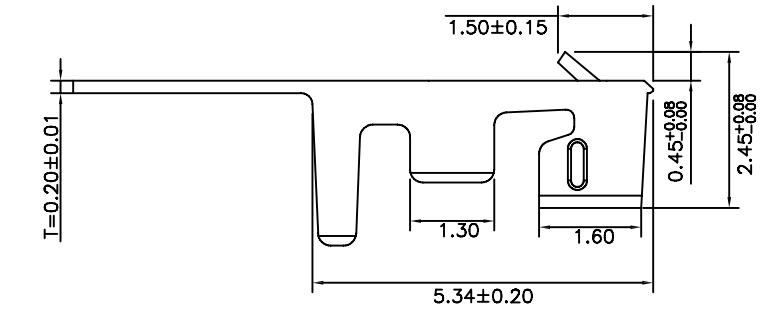

SPECIFICATIONS

- Voltage rating: 200V DC/AC (rms)
- Current rating: 1.0A
- Withstand voltage: 500V AC(rms)
- Working Temperature: -25°C +85°C
- Insulation resistance: ≥1000MΩ
- Contact resistance: ≤20mΩ

TERMINAL

- PART NO:A2017T
- THICKNESS:0.20MM
- MATERIAL:PHOSPHOR BRONZE
- FINISH:TIN--PLATED
- APPLICABLE WIRE:AWG#24-#28
- USE WITH: Housing: A2017H
- Q'TY:10000PCS/REEL

REV: A	APPROVE	CHECK	DRAWN
SHEET:1/1	FENG	ZENG	LIJIAN

MATERIAL:	GENERAL TOLERANCE	
UNIT: MM	X. ±0.30	X.* ±2°
SCALE: 3:1	X.X ±0.25	X.X* ±1°
SIZE: A4	X.XX ±0.15	⊕ ⊖

YSTZ 东莞市轩盟电子科技有限公司
DONGGUAN YSTZ ELECTRONIC TECHNOLOGY CO.,LTD

PART NO:A2017T-PC-1E-01

TITLE : JAE2.00mm Pitch Terminal

ROHS REACH

日期版次 REVISION	日期 DATE	变更内容 DESCRIPTION	核 准 APPROVALBY

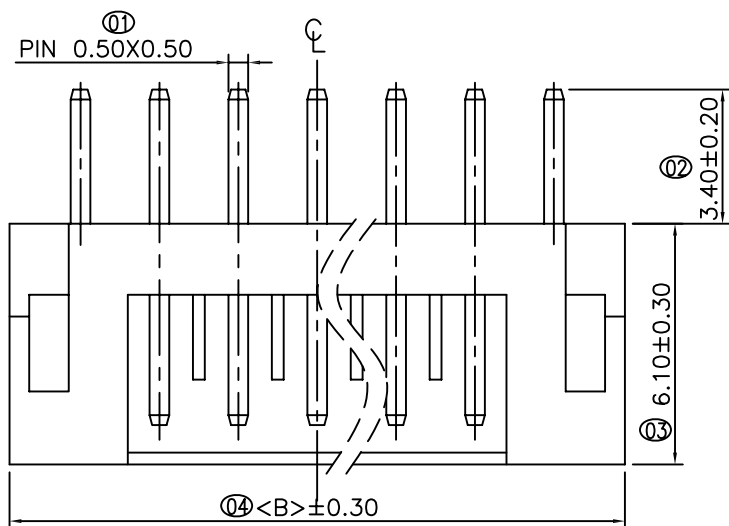

3P以上视图

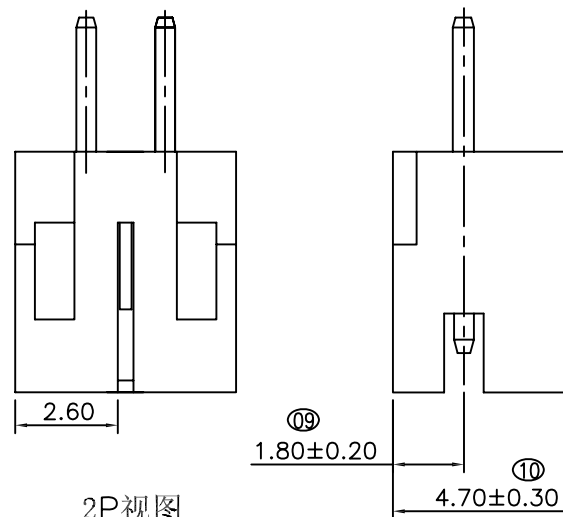

2P视图

SPECIFICATIONS

- Voltage rating: 200V DC/AC (rms)
- Current rating: 2.0A
- Withstand voltage: 500V AC(rms)
- Working Temperature: -25°C +85°C
- Insulation resistance: ≥1000MΩ
- Contact resistance: ≤20mΩ

poles	part no	dimensions (mm)	
		A	B
2	A2017V-2P	2.00	6.00
3	A2017V-3P	4.00	8.00
4	A2017V-4P	6.00	10.00
5	A2017V-5P	8.00	12.00
6	A2017V-6P	10.00	14.00
7	A2017V-7P	12.00	16.00
8	A2017V-8P	14.00	18.00
9	A2017V-9P	16.00	20.00
10	A2017V-10P	18.00	22.00
11	A2017V-11P	20.00	24.00
12	A2017V-12P	22.00	26.00
13	A2017V-13P	24.00	28.00
14	A2017V-14P	26.00	30.00
15	A2017V-15P	28.00	32.00
16	A2017V-16P	30.00	34.00

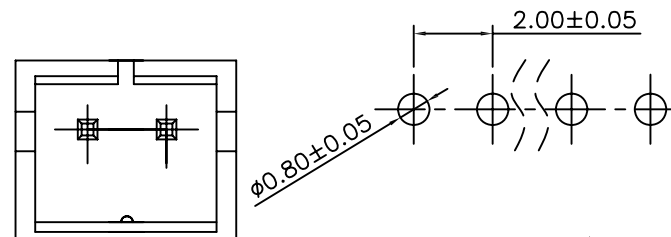
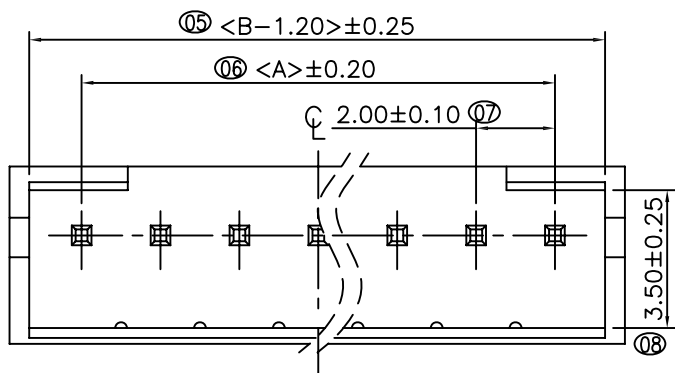

Recommended P.C.B Layout (Top Side)
THICKNESS = 1.20-1.60mm (TOLERANCE=±0.05)

PIN针	2--15	BRASS	HIGH TEMPERATURE WHDLE TIN
壳体	1	PA66 UL 94V-0	NATURE
PART NAME	PART NO.	MATERIALS	SPEC
REV: A	APPROVE	CHECK	DRAWN
SHEET:1/1	FENG	ZENG	LIJIAN

MATERIAL:	GENERAL TOLERANCE
UNIT: MM	X. ±0.30 X.* ±2°
SCALE: 3:1	X.X ±0.25 X.X* ±1°
SIZE: A4	X.XX ±0.15

YSTZ 东莞市轩盟电子科技有限公司
DONGGUAN YSTZ ELECTRONIC TECHNOLOGY CO.,LTD

PART NO: A2017V-NP-14E-01

TITLE : JAE2.0mm Pitch 180°-Wafer

ROHS REACH

日期版次	日期	变更内容	核 准
REVISION	DATE	DESCRIPTION	APPROVALBY

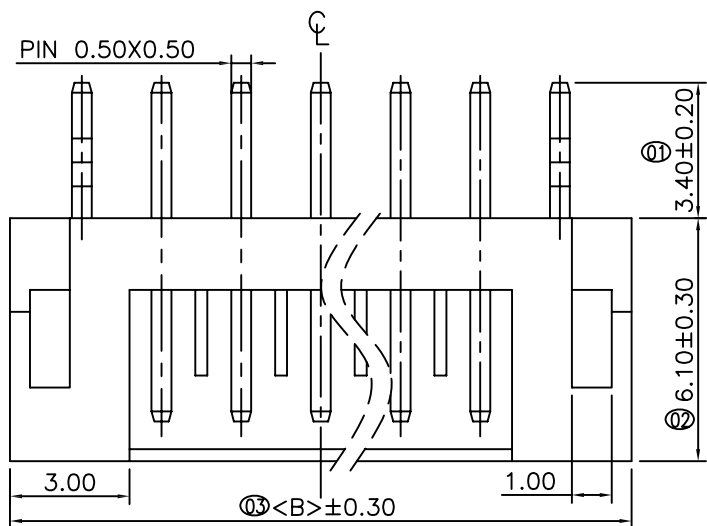

3P以上视图

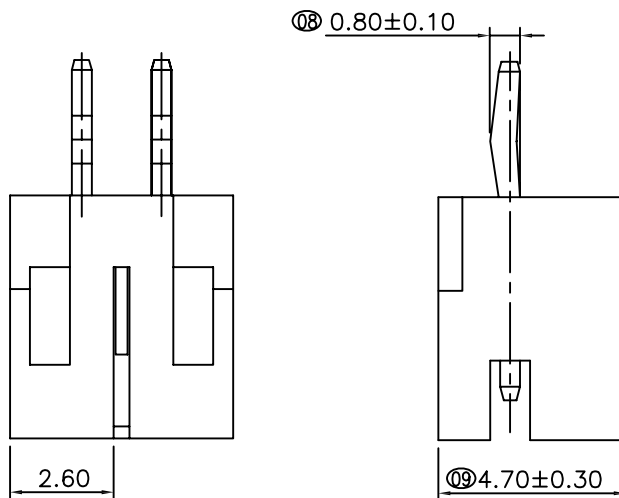

2P视图

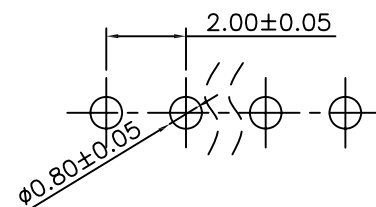
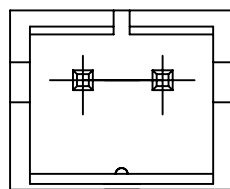
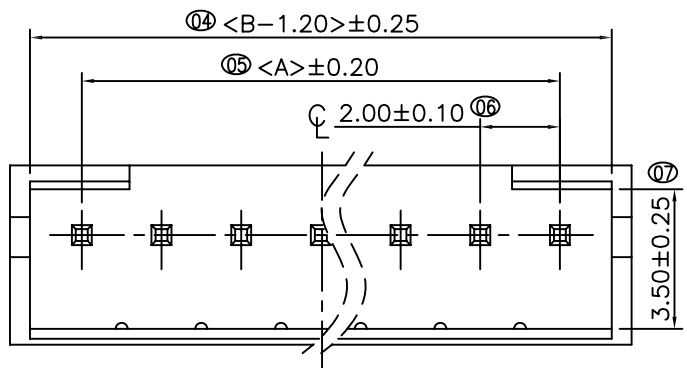

Recommended P.C.B Layout (Top Side)

THICKNESS = 1.20-1.60mm
(TOLERANCE=±0.05)

SPECIFICATIONS

- Voltage rating: 200V DC/AC (rms)
- Current rating: 2.0A
- Withstand voltage: 500V AC(rms)
- Working Temperature: -25°C+85°C
- Insulation resistance: ≥1000MΩ
- Contact resistance: ≤20mΩ

poles	part no	dimensions (mm)	
		A	B
2	A2017V-2P	2.00	6.00
3	A2017V-3P	4.00	8.00
4	A2017V-4P	6.00	10.00
5	A2017V-5P	8.00	12.00
6	A2017V-6P	10.00	14.00
7	A2017V-7P	12.00	16.00
8	A2017V-8P	14.00	18.00
9	A2017V-9P	16.00	20.00
10	A2017V-10P	18.00	22.00
11	A2017V-11P	20.00	24.00
12	A2017V-12P	22.00	26.00
13	A2017V-13P	24.00	28.00
14	A2017V-14P	26.00	30.00
15	A2017V-15P	28.00	32.00
16	A2017V-16P	30.00	34.00

PIN针	2--15	BRASS	HIGH TEMPERATURE WHDLE TIN
壳体	1	PA66 UL 94V-0	NATURE
PART NAME	PART NO.	MATERIALS	SPEC
REV: A	APPROVE	CHECK	DRAWN
SHEET:1/1	FENG	ZENG	LIJIAN

MATERIAL:	GENERAL TOLERANCE	
UNIT: MM	X. ±0.30	X.* ±2*
SCALE: 3:1	X.X ±0.25	X.X* ±1*
SIZE: A4	X.XX ±0.15	⊕ ⊖

YSTZ 东莞市轩盟电子科技有限公司
DONGGUAN YSTZ ELECTRONIC TECHNOLOGY CO.,LTD

PART NO: A2017V-NP-14K-01

TITLE : JAE2.0mm Pitch 180°-Wafer 打

ROHS REACH

日期版次	日期	变更内容	核 准
REVISION	DATE	DESCRIPTION	APPROVALBY

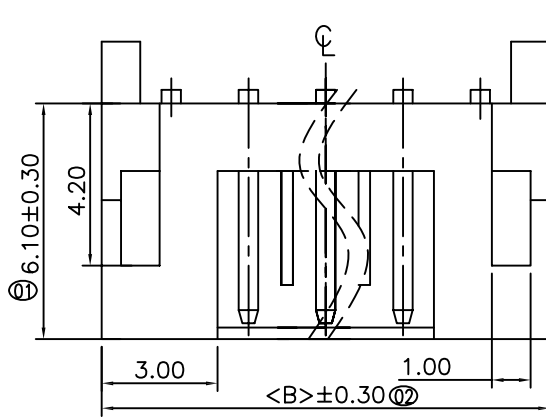

(3 Pin 以上视图)

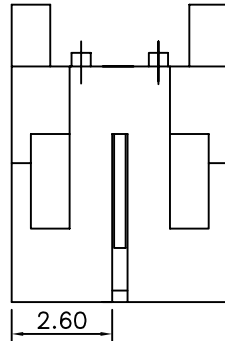

(2 Pin 视图)

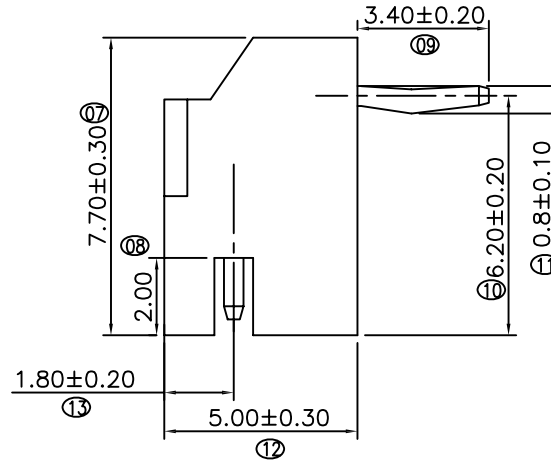

SPECIFICATIONS

- Voltage rating: 200V DC/AC (rms)
- Current rating: 2.0A
- Withstand voltage: 500V AC(rms)
- Working Temperature: -25°C +85°C
- Insulation resistance: ≥1000MΩ
- Contact resistance: ≤20mΩ

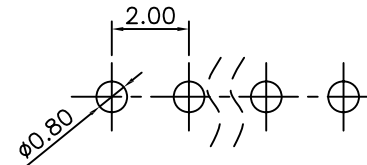
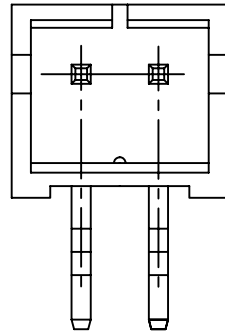
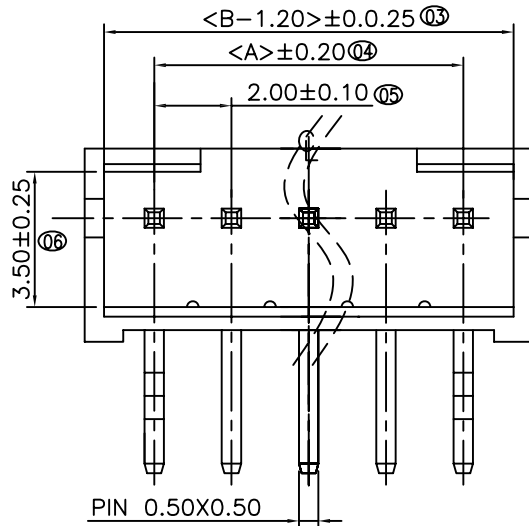

THICKNESS = 1.20-1.60mm (Tolerance=±0.05)
Recommended P.C.B Layout (Top Side)

poles	part no	dimensions (mm)	
		A	B
2	A2017R-2P	2.00	6.00
3	A2017R-3P	4.00	8.00
4	A2017R-4P	6.00	10.00
5	A2017R-5P	8.00	12.00
6	A2017R-6P	10.00	14.00
7	A2017R-7P	12.00	16.00
8	A2017R-8P	14.00	18.00
9	A2017R-9P	16.00	20.00
10	A2017R-10P	18.00	22.00
11	A2017R-11P	20.00	24.00
12	A2017R-12P	22.00	26.00
13	A2017R-13P	24.00	28.00
14	A2017R-14P	26.00	30.00
15	A2017R-15P	28.00	32.00
16	A2017R-16P	30.00	34.00

PIN针	2--15	BRASS	HIGH TEMPERATURE WHDLE TIN
壳体	1	PA66 UL 94V-0	NATURE
PART NAME	PART NO.	MATERIALS	SPEC
REV: A	APPROVE	CHECK	DRAWN
SHEET:1/1	FENG	ZENG	LIJIAN

MATERIAL:	GENERAL TOLERANCE	
UNIT: MM	X. ±0.30	X.* ±2*
SCALE: 3:1	X.X ±0.25	X.X* ±1*
SIZE: A4	X.XX ±0.15	⊕ ⊖

YSTZ 东莞市轩盟电子科技有限公司
DONGGUAN YSTZ ELECTRONIC TECHNOLOGY CO.,LTD

PART NO: A2017R-NP-14E-01

TITLE : JAE2.0mm Pitch 90°-Wafer