

ROHS REACH

| | | | |
|------------------|------------|---------------------|-------------------|
| | | | |
| | | | |
| | | | |
| 日期版次 REVISION | 日期 DATE | 变更内容 DESCRIPTION | 核 准 APPROVALBY |

SPECIFICATIONS

- Voltage rating: 125V DC/AC (rms)
- Current rating: 2.0A
- Withstand voltage: 1000V AC(rms)
- Working Temperature: -25°C +85°C
- Insulation resistance: ≥1000MΩ
- Contact resistance: ≤20MΩ

HOUSING

- PART NO: A2008H
- MATERIAL: NYLON66 94V-0
- COLOR: NATURAL(WHITE)
- USE WITH:
 - Terminal: A2008T
 - Wafer: A2008R A2008V
- Q'TY: 1000PCS/BAG

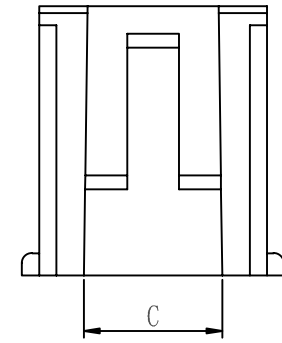
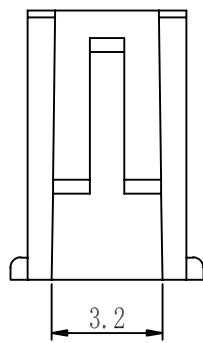
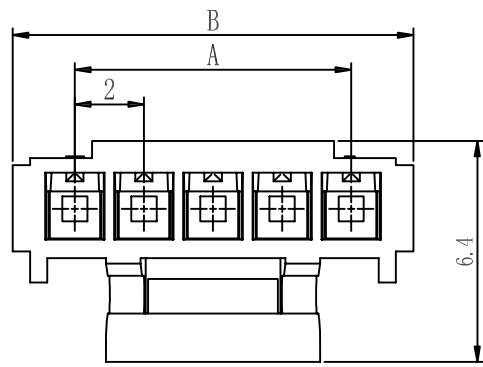
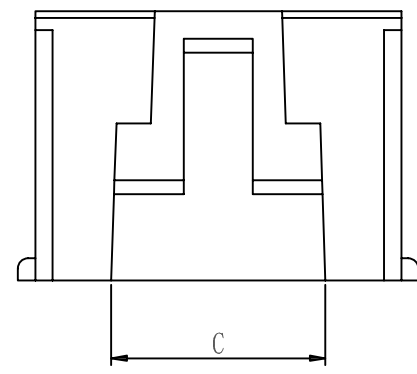
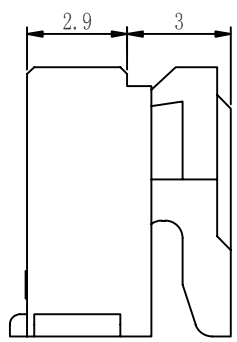
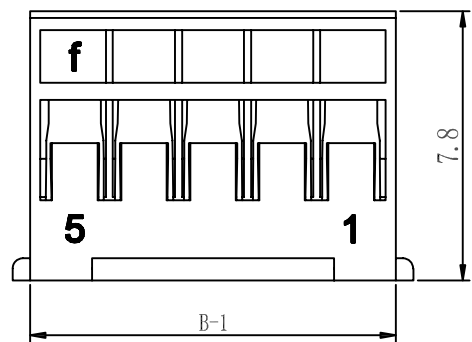

2P

3~4P

| poles | part no. | dimensions (mm) | | |
|-------|------------|-----------------|---------|-------|
| | | A | B | C |
| 2 | A2008H-2P | 2.00 | 5.60 | 3.20 |
| 3 | A2008H-3P | 4.00 | 7.60 | 4.00 |
| 4 | A2008H-4P | 6.00 | 9.60 | 5.00 |
| 5 | A2008H-5P | 8.00 | 1106.00 | 6.20 |
| 6 | A2008H-6P | 10.00 | 13.60 | 8.20 |
| 7 | A2008H-7P | 12.00 | 15.60 | 10.20 |
| 8 | A2008H-8P | 14.00 | 17.60 | 12.20 |
| 9 | A2008H-9P | 16.00 | 19.60 | 14.20 |
| 10 | A2008H-10P | 18.00 | 21.60 | 16.20 |
| 11 | A2008H-11P | 20.00 | 23.60 | 14.20 |
| 12 | A2008H-12P | 22.00 | 25.60 | 16.20 |
| 13 | A2008H-13P | 24.00 | 27.60 | 16.20 |
| 14 | A2008H-14P | 26.00 | 29.60 | 16.20 |
| 15 | A2008H-15P | 28.00 | 31.60 | 16.20 |
| 16 | A2008H-16P | 30.00 | 33.60 | 16.20 |

| | | | | | | | |
|-----------|---------|-------|--------|------------|-------------------|----------|--|
| REV: A | APPROVE | CHECK | DRAWN | MATERIAL: | GENERAL TOLERANCE | | 东莞市轩盟电子科技有限公司 DONGGUAN YSTZ ELECTRONIC TECHNOLOGY CO.,LTD PART NO: A2008H-NP-10D-06 TITLE : PHS2.00mm Pitch Housing |
| SHEET:1/1 | FENG | ZENG | LIJIAN | UNIT: MM | X. ±0.30 | X.* ±2° | |
| | | | | SCALE: 3:1 | X.X ±0.25 | X.X* ±1° | |
| | | | | SIZE: A4 | X.XX ±0.15 | | |

ROHS REACH

| | | | |
|------------------|------------|---------------------|-------------------|
| | | | |
| | | | |
| 日期版次 REVISION | 日期 DATE | 变更内容 DESCRIPTION | 核 准 APPROVALBY |

SPECIFICATIONS

- Voltage rating: 100V DC/AC (rms)
- Current rating: 2.0A
- Withstand voltage: 800V AC(rms)
- Working Temperature: -25℃ +85℃
- Insulation resistance: ≥1000MΩ
- Contact resistance: ≤20mΩ

TERMINAL

- PART NO: A2008T
- THICKNESS: 0.20MM
- MATERIAL: PHOSPHOR BRONZE
- FINISH: TIN--PLATED
- APPLICABLE WIRE: AWG#22-#30
- USE WITH: Housing: A2008H
- Q'TY: 12000PCS/REEL

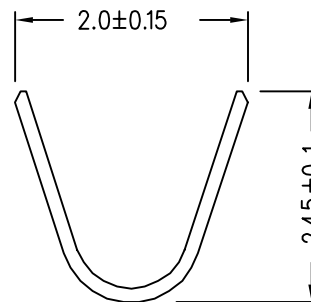
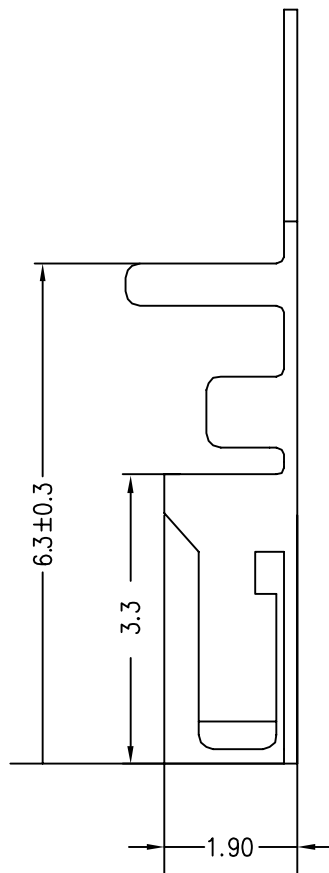
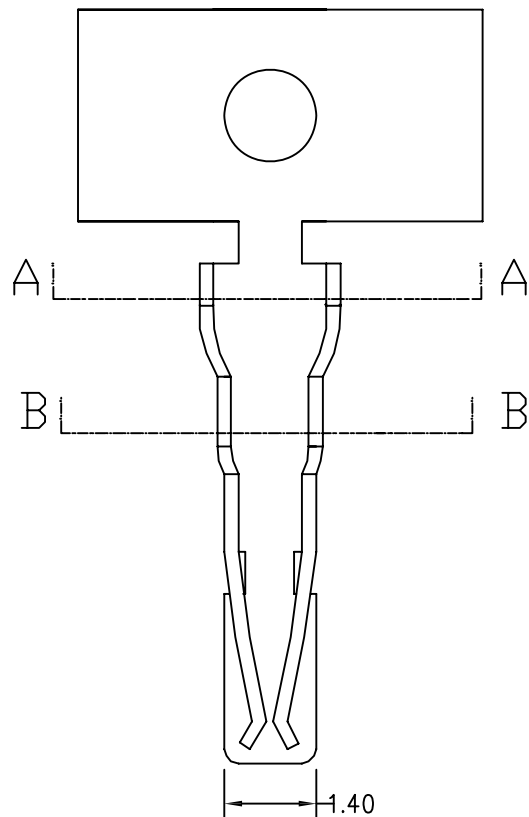

A-A

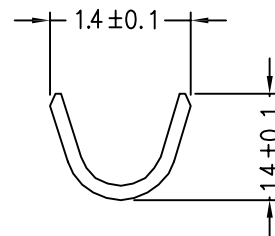

B-B

| | | | | | | |
|------------|---------|-------|--------|------------|--------------------|---|
| REV: A | APPROVE | CHECK | DRAWN | MATERIAL: | GENERAL TOLERANCE | 东莞市轩盟电子科技有限公司 DONGGUAN YSTZ ELECTRONIC TECHNOLOGY CO.,LTD PART NO: A2008T-PC-1D-06 TITLE: PHS2.00mm Pitch Terminal |
| SHEET: 1/1 | FENG | ZENG | LIJIAN | UNIT: MM | X. ±0.30 X.* ±2° | |
| | | | | SCALE: 3:1 | X.X ±0.25 X.X* ±1° | |
| | | | | SIZE: A4 | X.XX ±0.15 | |

ROHS REACH

| | | | |
|----------|------|-------------|------------|
| | | | |
| | | | |
| 日期版次 | 日期 | 变更内容 | 核 准 |
| REVISION | DATE | DESCRIPTION | APPROVALBY |

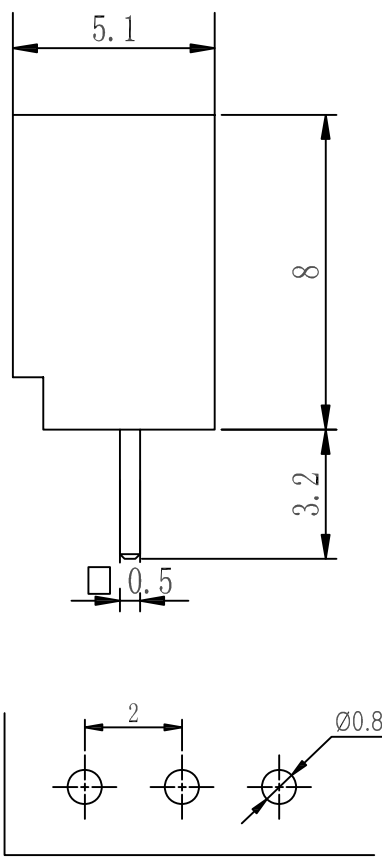
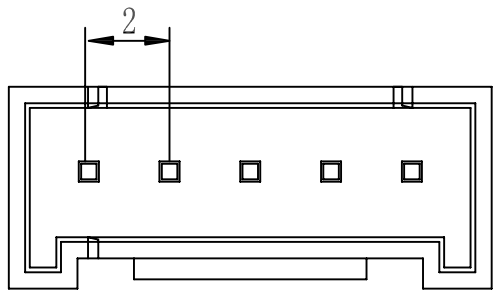
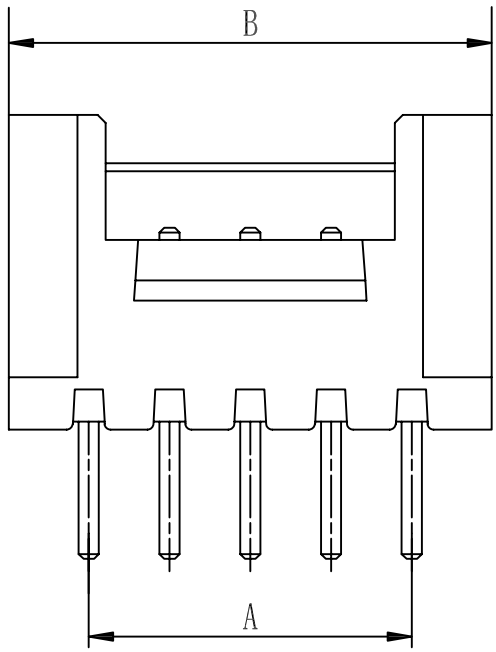

P. C. BLAYOUT

SPECIFICATIONS

- Voltage rating: 125V DC/AC (rms)
- Current rating: 2.0A
- Withstand voltage: 1000V AC(rms)
- Working Temperature: -25°C +85°C
- Insulation resistance: ≥1000MΩ
- Contact resistance: ≤20mΩ

| poles | part no. | dimensions (mm) | |
|-------|------------|-----------------|-------|
| | | A | B |
| 2 | A2008V-2P | 2.00 | 6.00 |
| 3 | A2008V-3P | 4.00 | 8.00 |
| 4 | A2008V-4P | 6.00 | 10.00 |
| 5 | A2008V-5P | 8.00 | 12.00 |
| 6 | A2008V-6P | 10.00 | 14.00 |
| 7 | A2008V-7P | 12.00 | 16.00 |
| 8 | A2008V-8P | 14.00 | 18.00 |
| 9 | A2008V-9P | 16.00 | 20.00 |
| 10 | A2008V-10P | 18.00 | 22.00 |
| 11 | A2008V-11P | 20.00 | 24.00 |
| 12 | A2008V-12P | 22.00 | 26.00 |
| 13 | A2008V-13P | 24.00 | 28.00 |
| 14 | A2008V-14P | 26.00 | 30.00 |
| 15 | A2008V-15P | 28.00 | 32.00 |
| 16 | A2008V-16P | 30.00 | 34.00 |

| | | | |
|-----------|---------|---------------|------------|
| PIN针 | 2-16 | BRASS | TIN-PLATED |
| 壳体 | 1 | PA66 UL 94V-0 | WHITE |
| PART NAME | QTY. | MATERIALS | SPEC |
| REV: A | APPROVE | CHECK | DRAWN |
| SHEET:1/1 | FENG | ZENG | LIJIAN |

| | | |
|------------|-------------------|----------|
| MATERIAL: | GENERAL TOLERANCE | |
| UNIT: MM | X. ±0.30 | X.* ±2° |
| SCALE: 3:1 | X.X ±0.25 | X.X* ±1° |
| SIZE: A4 | X.XX ±0.15 | ⊕ ⊖ |

YSTZ 东莞市轩盟电子科技有限公司
 DONGGUAN YSTZ ELECTRONIC TECHNOLOGY CO.,LTD

PART NO: A2008V-NP-10D-06

TITLE : PHS2.00mm Pitch 180° Wafer

ROHS REACH

| | | | |
|------------------|------------|---------------------|-------------------|
| | | | |
| | | | |
| | | | |
| 日期版次 REVISION | 日期 DATE | 变更内容 DESCRIPTION | 核 准 APPROVALBY |

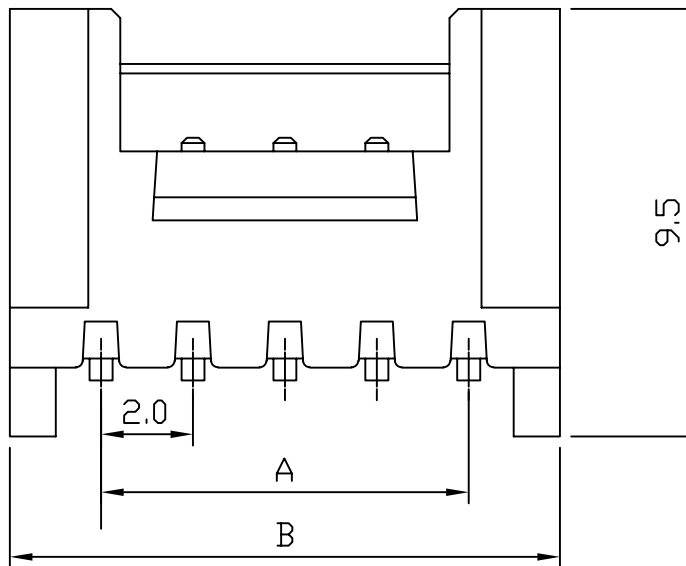
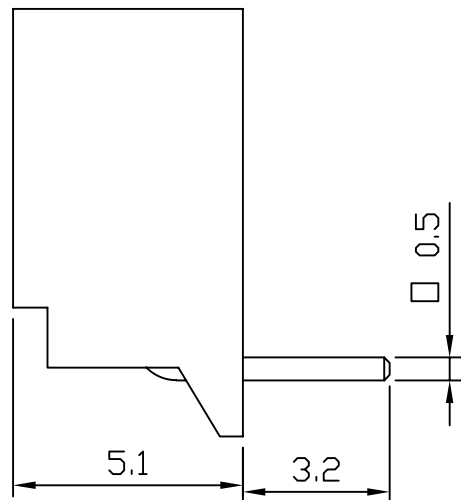

SPECIFICATIONS

- Voltage rating: 125V DC/AC (rms)
- Current rating: 2.0A
- Withstand voltage: 1000V AC(rms)
- Working Temperature: -25°C +85°C
- Insulation resistance: ≥1000MΩ
- Contact resistance: ≤20mΩ

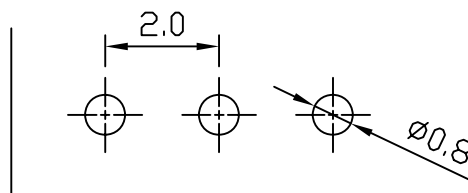

P. C. BLAYOUT

| poles | paRDt no. | dimensions (mm) | |
|-------|-------------|-----------------|-------|
| | | A | B |
| 2 | A2008RD-2P | 2.00 | 6.00 |
| 3 | A2008RD-3P | 4.00 | 8.00 |
| 4 | A2008RD-4P | 6.00 | 10.00 |
| 5 | A2008RD-5P | 8.00 | 12.00 |
| 6 | A2008RD-6P | 10.00 | 14.00 |
| 7 | A2008RD-7P | 12.00 | 16.00 |
| 8 | A2008RD-8P | 14.00 | 18.00 |
| 9 | A2008RD-9P | 16.00 | 20.00 |
| 10 | A2008RD-10P | 18.00 | 22.00 |
| 11 | A2008RD-11P | 20.00 | 24.00 |
| 12 | A2008RD-12P | 22.00 | 26.00 |
| 13 | A2008RD-13P | 24.00 | 28.00 |
| 14 | A2008RD-14P | 26.00 | 30.00 |
| 15 | A2008RD-15P | 28.00 | 32.00 |
| 16 | A2008RD-16P | 30.00 | 34.00 |

| | | | |
|-----------|---------|---------------|------------|
| PIN针 | 2-16 | BRASS | TIN-PLATED |
| 壳体 | 1 | PA66 UL 94V-0 | WHITE |
| PART NAME | QTY. | MATERIALS | SPEC |
| REV: A | APPROVE | CHECK | DRAWN |
| SHEET:1/1 | FENG | ZENG | LIJIAN |

| | | |
|------------|-------------------|----------|
| MATERIAL: | GENERAL TOLERANCE | |
| UNIT: MM | X. ±0.30 | X.* ±2* |
| SCALE: 3:1 | X.X ±0.25 | X.X* ±1* |
| SIZE: A4 | X.XX ±0.15 | ⊕ ⊖ |

YSTZ 东莞市轩盟电子科技有限公司
DONGGUAN YSTZ ELECTRONIC TECHNOLOGY CO.,LTD

PART NO: A2008RD-NP-10D-06

TITLE: PHS2.00mm Pitch 90° Wafer