

ROHS REACH

日期版次 REVISION	日期 DATE	变更内容 DESCRIPTION	核 准 APPROVALBY

SPECIFICATIONS

- Voltage rating: 150V DC/AC (rms)
- Current rating: 1.0A
- Withstand voltage: 500V AC(rms)
- Working Temperature: -25℃ +85℃
- Insulation resistance: ≥100MΩ
- Contact resistance: ≤30MΩ

HOUSING

- PART NO: A1255H-NP
- MATERIAL: NYLON66 94V-0
- COLOR: NATURAL(WHITE)
- USE WITH:
Terminal: A1255T
Wafer: A1255RS A1255VS
- Q'TY: 1000PCS/BAG

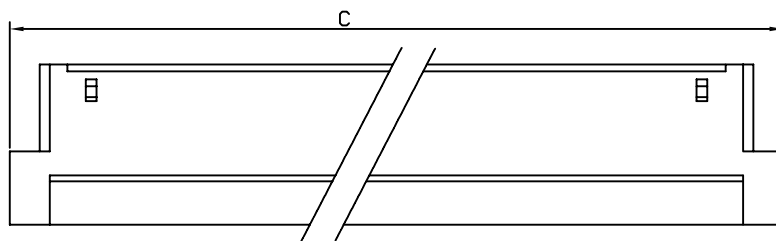
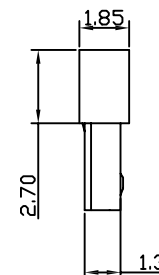
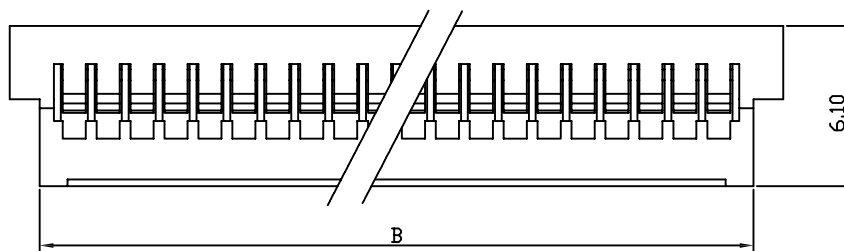
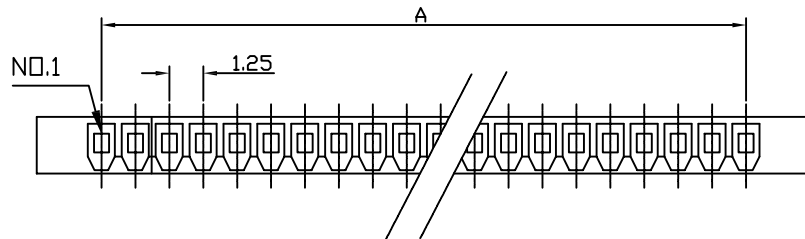

poles	part no.	dimensions (mm)		
		A	B	C
2	A1255H-2P	1.25	3.80	6.00
3	A1255H-3P	2.50	5.05	7.25
4	A1255H-4P	3.75	6.30	8.50
5	A1255H-5P	5.00	7.55	9.75
6	A1255H-6P	6.25	8.80	11.00
7	A1255H-7P	7.50	10.05	12.25
8	A1255H-8P	8.75	11.30	13.50
9	A1255H-9P	10.00	12.55	14.75
10	A1255H-10P	11.25	13.80	16.00
15	A1255H-15P	17.50	20.05	22.25
20	A1255H-20P	23.75	26.30	28.50
25	A1255H-25P	30.00	32.55	34.75
30	A1255H-30P	36.25	38.80	41.00

REV: A	APPROVE	CHECK	DRAWN	MATERIAL:	GENERAL TOLERANCE		东莞市轩盟电子科技有限公司 DONGGUAN YSTZ ELECTRONIC TECHNOLOGY CO.,LTD
SHEET:1/1	FENG	ZENG	LIJIAN	UNIT: MM	X. ±0.30	X.* ±2°	
				SCALE: 3:1	X.X ±0.25	X.X* ±1°	
				SIZE: A4	X.XX ±0.15		PART NO: A1255H-NP-10E-02
							TITLE : FIS1.25MM PITCH HOUSING

ROHS REACH

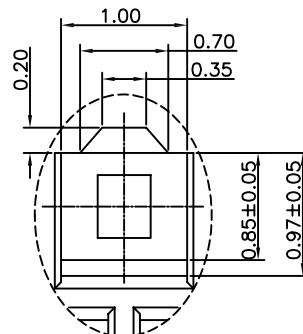
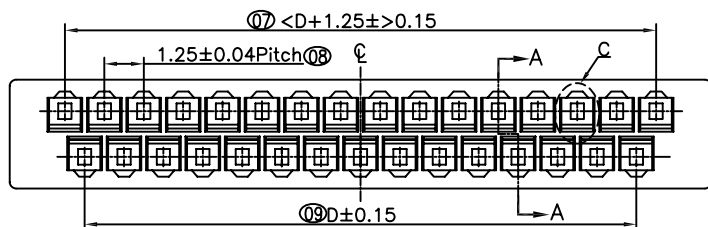
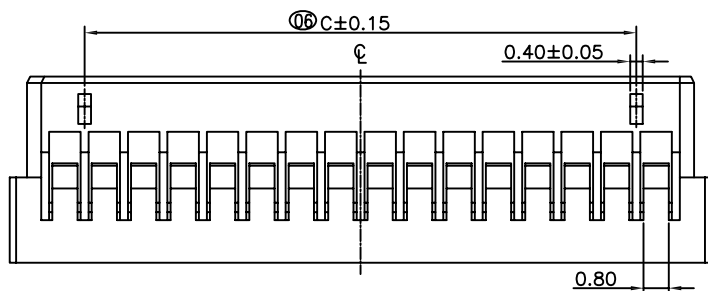
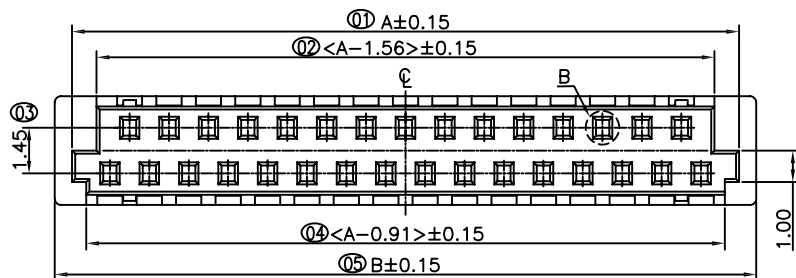
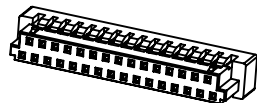

SECTOR: C (4:1)

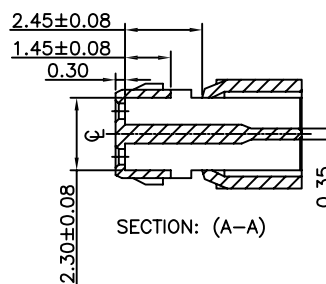
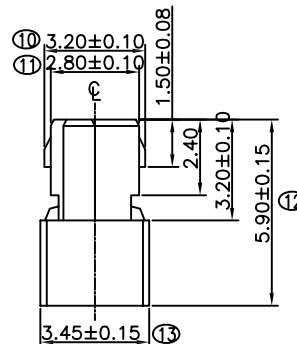

SECTION: (A-A)

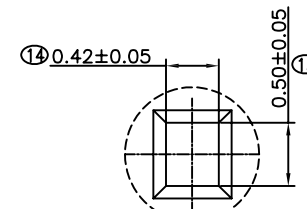

SECTOR: B (4:1)

SPECIFICATIONS

- Voltage rating: 200V DC/AC (rms)
- Current rating: 1.0A
- Withstand voltage: 500V AC(rms)
- Working Temperature: -25°C+85°C
- Insulation resistance: ≥100MΩ
- Contact resistance: ≤20MΩ

HOUSING

- PART NO: A1256H
- MATERIAL: PA66+15%GF 94V-0
- COLOR: BLACK
- USE WITH:
 - Terminal: A125T
 - Wafer: A1256R A1256V
- Q'TY: 1000PCS/BAG

poles	part no.	dimensions (mm)			
		A	B	C	D
21	A1256H-21P	14.91	16.00	11.25	11.25
31	A1256H-31P	21.16	22.25	17.50	17.50
41	A1256H-41P	27.41	28.50	23.75	23.75
51	A1256H-51P	33.66	34.75	30.00	30.00

MATERIAL:
PA66UL94-V0

GENERAL TOLERANCE

UNIT: MM

X. ±0.30 X.* ±2°

SCALE: 3:1

X.X ±0.25 X.X* ±1°

SIZE: A4

X.XX ±0.15

YSTZ 东莞市轩盟电子科技有限公司
DONGGUAN YSTZ ELECTRONIC TECHNOLOGY CO.,LTD

PART NO: A1256H-NP-11E-01

TITLE : FIS1.25MM PITCH Dual Row HOUSING

REV: A	APPROVE	CHECK	DRAWN
SHEET:1/1	FENG	ZENG	LIJIAN

ROHS REACH

日期版次	日期	变更内容	核 准
REVISION	DATE	DESCRIPTION	APPROVALBY

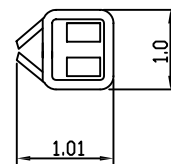
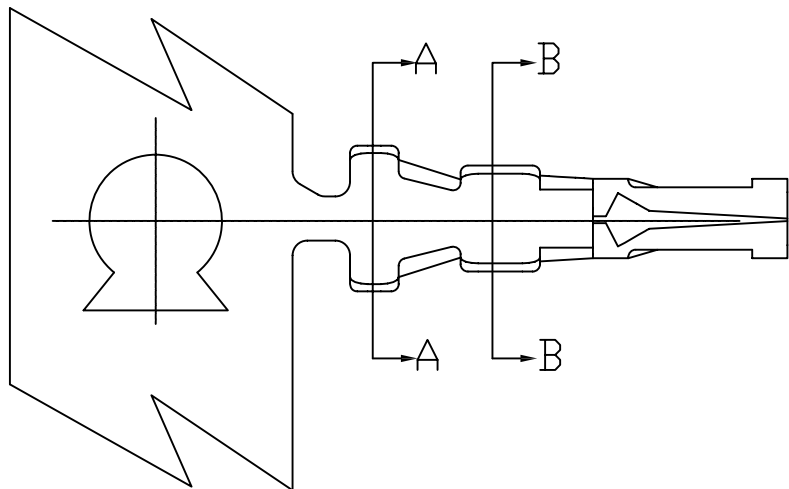

SPECIFICATIONS

- Voltage rating: 150V DC/AC (rms)
- Current rating: 1.0A
- Withstand voltage: 500V AC(rms)
- Working Temperature: -25℃+85℃
- Insulation resistance: ≥100MΩ
- Contact resistance: ≤30mΩ

TERMINAL

- PART NO: A1255T
- THICKNESS: 0.15MM
- MATERIAL: PHOSPHOR BRONZE
- FINISH: GOLD-PLATED
- APPLICABLE WIRE: AWG#28-#32
- USE WITH: Housing: A1255H
- Q'TY: 10000PCS/REEL

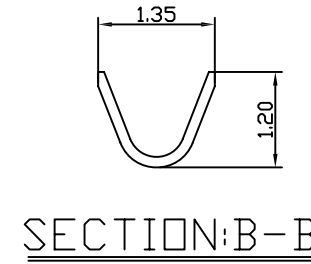
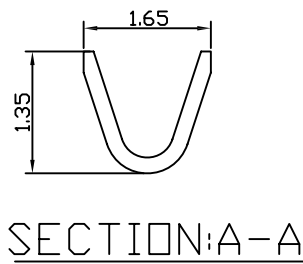
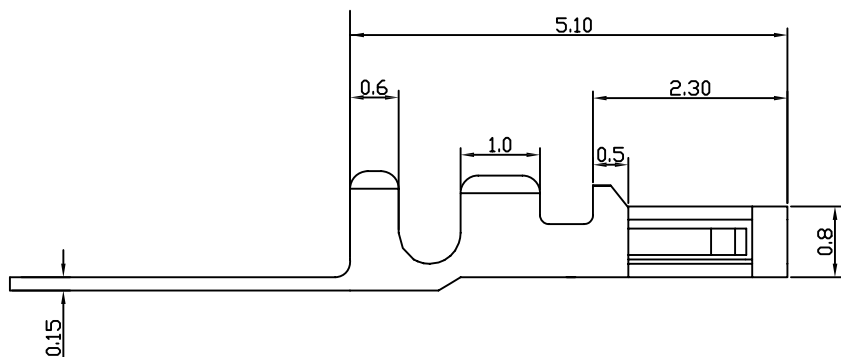

				MATERIAL:	GENERAL TOLERANCE		东莞市轩盟电子科技有限公司 DONGGUAN YSTZ ELECTRONIC TECHNOLOGY CO.,LTD PART NO: A1255T-PC-1E-02 TITLE : FIS1.25mm Pitch Terminal
REV: A	APPROVE	CHECK	DRAWN	UNIT: MM	X. ±0.30	X.* ±2°	
SHEET: 1/1	FENG	ZENG	LIJIAN	SCALE: 3:1	X.X ±0.25	X.X* ±1°	
				SIZE: A4	X.XX ±0.15		