

ROHS REACH

日期版次	日期	变更内容	核 准
REVISION	DATE	DESCRIPTION	APPROVALBY

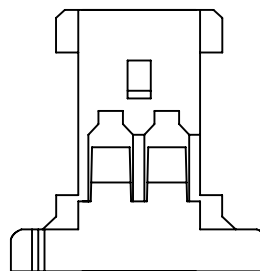
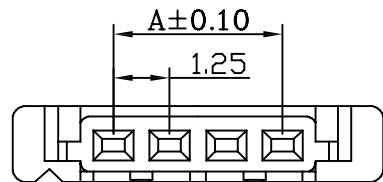

2P

SPECIFICATIONS

- Voltage rating: 100V DC/AC (rms)
- Current rating: 1.0A
- Withstand voltage: 250V AC(rms)
- Working Temperature: -25℃+85℃
- Insulation resistance: ≥100MΩ
- Contact resistance: ≤20MΩ

HOUSING

- PART NO: A1254H
- MATERIAL: NYLON66 94V-0
- COLOR: NATURAL(WHITE)
- USE WITH:
Terminal: A1254T
Wafer: A1254RS
- Q'TY: 1000PCS/BAG

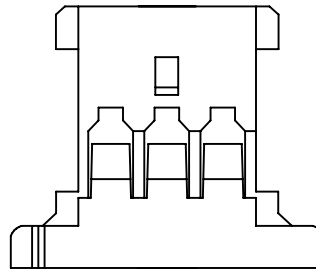
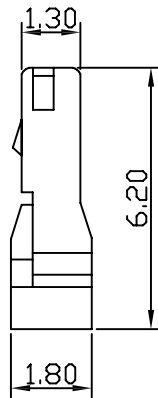
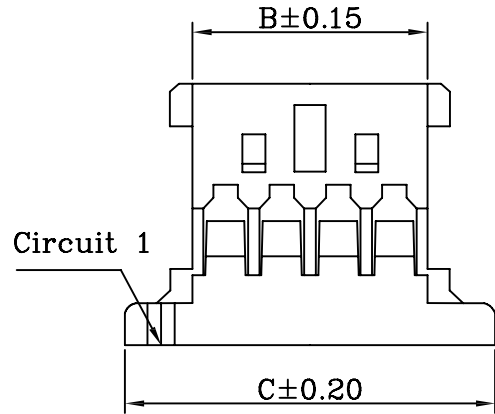

3P

poles	part no.	dimenstions (mm)		
		A	B	C
2	A1254H-2P	1.25	2.72	5.72
3	A1254H-3P	2.50	3.97	6.97
4	A1254H-4P	3.75	5.22	8.22
5	A1254H-5P	5.00	6.47	9.47
6	A1254H-6P	6.25	7.72	10.72
7	A1254H-7P	7.50	8.97	11.97
8	A1254H-8P	8.75	10.22	13.22
9	A1254H-9P	10.00	11.47	14.47
10	A1254H-10P	11.25	12.72	15.72
11	A1254H-11P	12.50	13.97	16.97
12	A1254H-12P	13.75	15.22	18.22
14	A1254H-14P	16.25	17.72	20.72
15	A1254H-15P	17.50	18.97	21.97
20	A1254H-20P	23.75	25.22	28.22
30	A1254H-30P	36.25	37.72	40.72

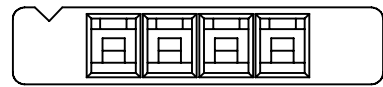

MATERIAL: PA66UL94-V0	GENERAL TOLERANCE	
UNIT: MM	X. ±0.30	X.* ±2*
SCALE: 3:1	X.X ±0.25	X.X* ±1*
SIZE: A4	X.XX ±0.15	⊕ ⊖

YSTZ 东莞市轩盟电子科技有限公司
DONGGUAN YSTZ ELECTRONIC TECHNOLOGY CO.,LTD

REV: A	APPROVE	CHECK	DRAWN
SHEET:1/1	FENG	ZENG	LIJIAN

PART NO: A1254H-NP-10E-02
TITLE : 1.25MM PITCH HOUSING

ROHS REACH

日期版次 REVISION	日期 DATE	变更内容 DESCRIPTION	核 准 APPROVALBY

SPECIFICATIONS

- Voltage rating: 100V DC/AC (rms)
- Current rating: 1.0A
- Withstand voltage: 250V AC(rms)
- Working Temperature: -25°C +85°C
- Insulation resistance: ≥100MΩ
- Contact resistance: ≤20mΩ

TERMINAL

- PART NO: A1254T
- THICKNESS: 0.15MM
- MATERIAL: PHOSPHOR BRONZE
- FINISH: TIN-PLATED/GOLD-PLATED
- APPLICABLE WIRE: AWG#28-#32
- USE WITH: Housing: A1254H
- Q'TY: 150000PCS/REEL

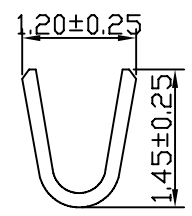
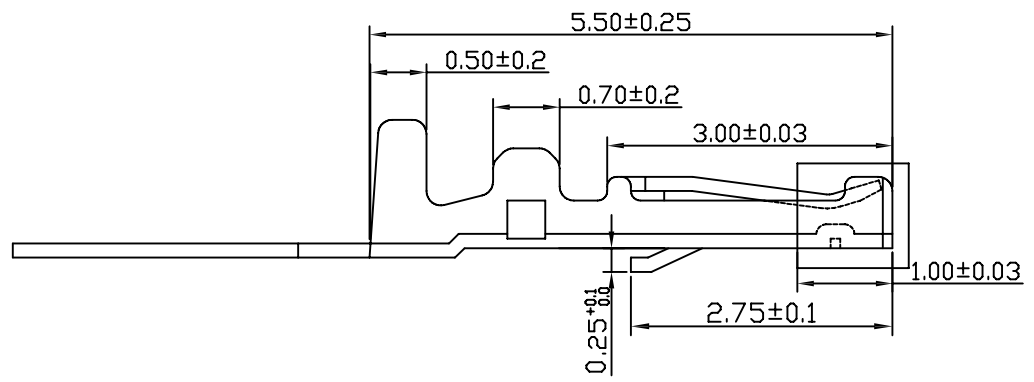
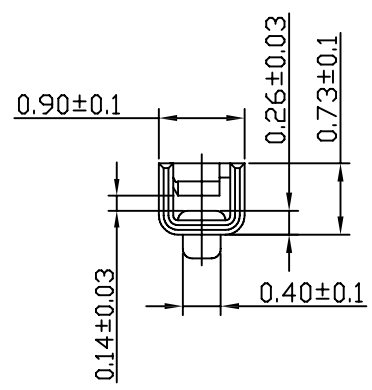
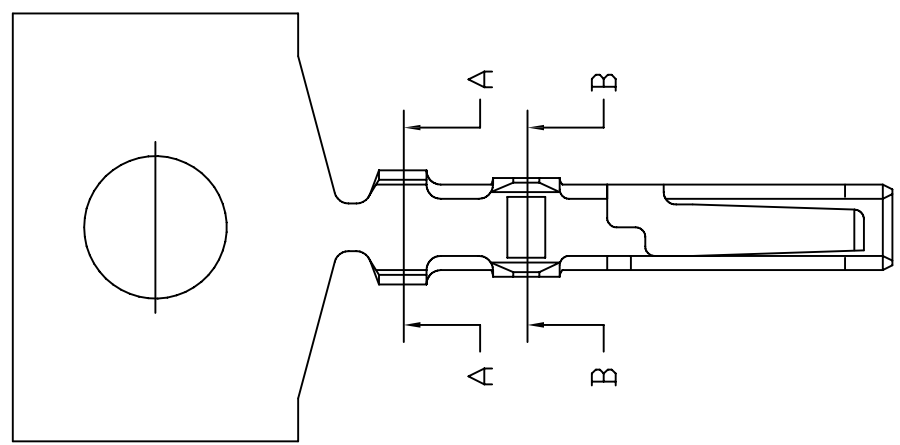

SEC:A-A

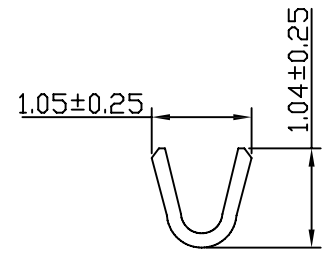

SEC:B-B

REV: A	APPROVE	CHECK	DRAWN	MATERIAL:	GENERAL TOLERANCE		东莞市轩盟电子科技有限公司 DONGGUAN YSTZ ELECTRONIC TECHNOLOGY CO.,LTD
	FENG	ZENG	LIJIAN	UNIT: MM	X. ±0.30	X.* ±2*	
	SHEET:1/1			SCALE: 3:1	X.X ±0.25	X.X* ±1*	
				SIZE: A4	X.XX ±0.15		PART NO: A1254T-PC-2E-02
							TITLE : 1.25mm Pitch Terminal

ROHS REACH

日期版次	日期	变更内容	核 准
REVISION	DATE	DESCRIPTION	APPROVALBY

SPECIFICATIONS

- Voltage rating: 100V DC/AC (rms)
- Current rating: 1.0A
- Withstand voltage: 250V AC(rms)
- Working Temperature: -25°C+85°C
- Insulation resistance: ≥100MΩ
- Contact resistance: ≤20mΩ

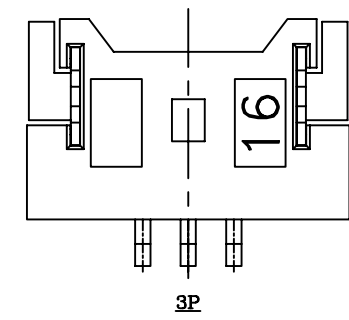
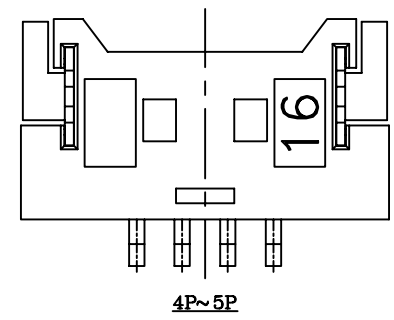
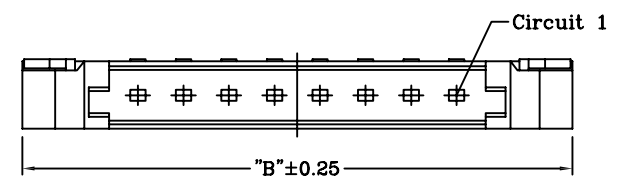
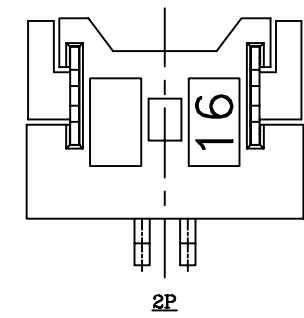
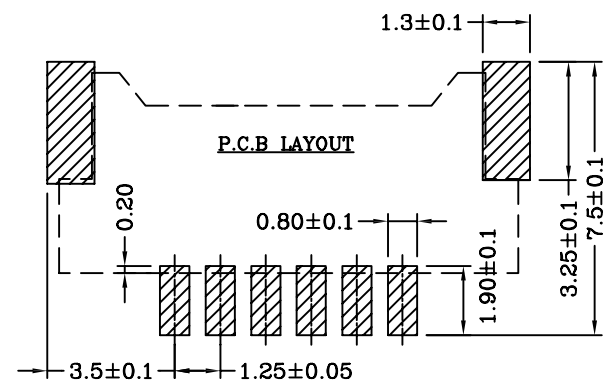
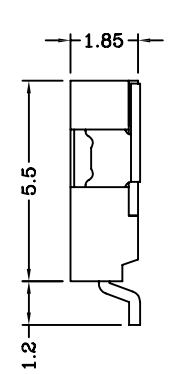
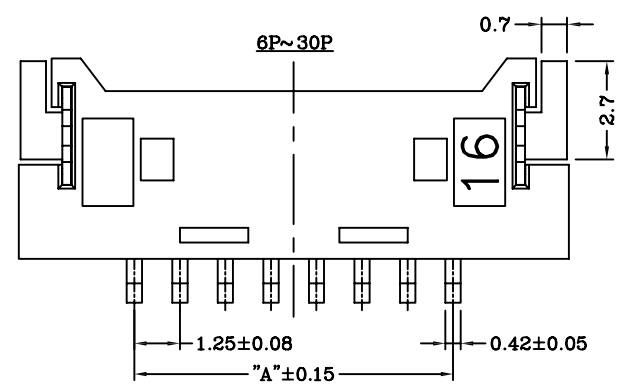

poles	part no.	dimensions (mm)	
		A	B
2	A1254RS-2P	1.25	7.65
3	A1254RS-3P	2.50	8.90
4	A1254RS-4P	3.75	10.15
5	A1254RS-5P	5.00	11.40
6	A1254RS-6P	6.25	12.65
7	A1254RS-7P	7.50	13.90
8	A1254RS-8P	8.75	15.15
9	A1254RS-9P	10.00	16.40
10	A1254RS-10P	11.25	17.65
11	A1254RS-11P	12.50	18.90
12	A1254RS-12P	13.75	20.15
13	A1254RS-13P	15.00	21.40
14	A1254RS-14P	16.25	22.65
15	A1254RS-15P	17.50	23.90
20	A1254RS-20P	23.75	30.15
30	A1254RS-30P	36.25	42.65

PIN针	2--30	BRASS	HIGH TEMPERATURE WHOLE TIN
定位片	2	BRASS	HIGH TEMPERATURE WHOLE TIN
壳体	1	PA9T UL 94V-D	NATURAL

PART NAME	PART NO.	MATERIALS	SPEC
REV: A	APPROVE	CHECK	DRAWN
SHEET:1/1	FENG	ZENG	LIJIAN

MATERIAL:	GENERAL TOLERANCE	
UNIT: MM	X. ±0.30	X.* ±2°
SCALE: 3:1	X.X ±0.25	X.X* ±1°
SIZE: A4	X.XX ±0.15	⊕ ⊖

YSTZ 东莞市轩盟电子科技有限公司
 DONGGUAN YSTZ ELECTRONIC TECHNOLOGY CO.,LTD
 PART NO: A1254RS-NP-71E-04
 TITLE: MX1.25mm Pitch 90°SMT 超薄 WAFER