

# ROHS REACH

日期版次 REVISION	日期 DATE	变更内容 DESCRIPTION	核 准 APPROVAL

## SPECIFICATIONS

备注 (Remark)

### 1. 材料 (MATERIAL)

胶芯: PA6T+30%G.F UL94V-0, 颜色: 黑色  
 Housing: PA6T+30%G.F UL94V-0, Color: Black  
 四方针: 黄铜, 镍底30U"MIN, 表面镀金0.8U"MIN  
 Contact: Brass, 0.8u"min Gold Plating Over All  
 30u"min Nickel Underplating Over All

### 2. 特性 (characteristics):

额定电流: 2.0 AMP  
 Raring Current: 2.0 AMP  
 接触阻抗: 20MΩ MAX  
 Contact Resistance: 20mΩ Max  
 绝缘阻抗: 1000MΩ MIN  
 Insulation Resistance: 1000MΩ Min  
 耐电压: AC 500V  
 Withstand Voltage: 500V AC/DC  
 温度范围: -40°C to +105°C  
 Operation Temperature: -40°C to +105°C

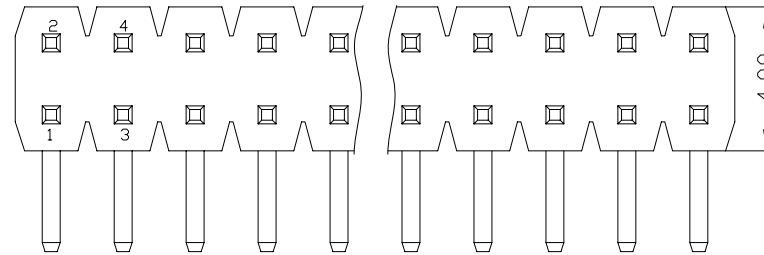

## Ordering Information

P2000R-12 XX XX X XX XXX X 1

No. of Pins Per Row 2-40	Contact Plating Full of Glod A0=0.8U" A1=1U" A2=1.5U" A3=2U" A4=3U" A5=5U" A6=10U" A7=15U" A8=20U" A9=30U"	Semi-gold B0=0.8U" B0=1.5U" B0=2U" B0=3U" B0=5U" B0=10U" B0=15U" B0=20U" B0=30U"	Insulatot Material B=BK-PA6T C=BK-PA9T D=BK-LCP	HEIGHT OF HOUSING 101.0mm 151.5mm 202.0mm	Length of Terminal	Packing A=PE Bag T=Tape&Reel C=Tube D=Tube+Cap E=Tray
	S1=Ordinary Tin Plated S2=Matte Tin Plated S3=Tin-platde High-temperature					

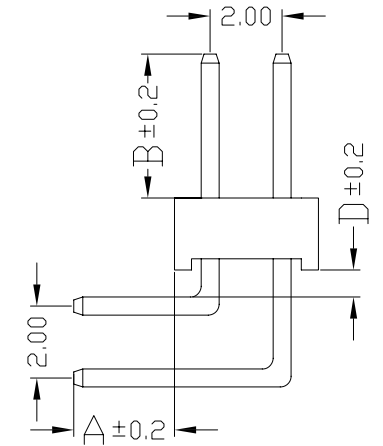
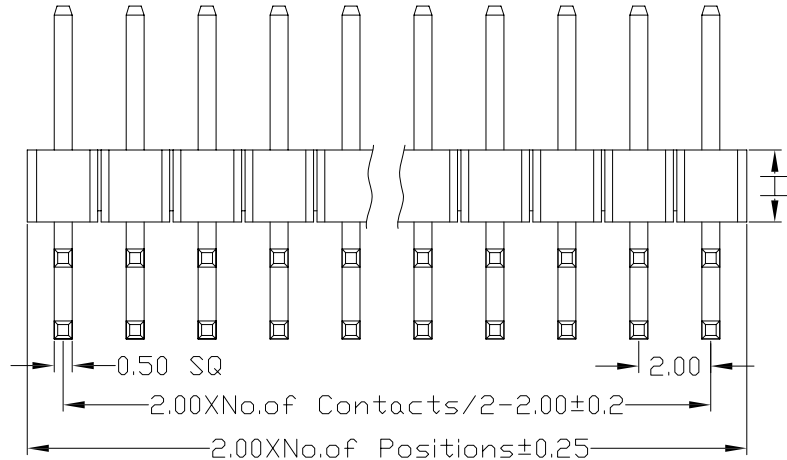
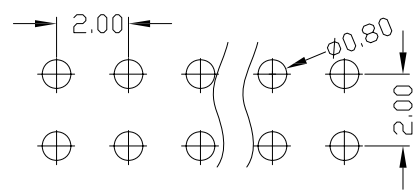

ITEM	A	B	H	D
Standard	2.8	4	1 1.5 2	0 0.75
Alternate				

REV: A	APPROVE	CHECK	DRAWN	MATERIAL:	GENERAL TOLERANCE
SHEET:1/1	FENG	ZENG	LIJIAN	UNIT: MM	X. ±0.30 X.* ±2°
				SCALE: 3:1	X.X ±0.25 X.X* ±1°
				SIZE: A4	X.XX ±0.15

**YSTZ 东莞市轩盟电子科技有限公司**  
 DONGGUAN YSTZ ELECTRONIC TECHNOLOGY CO.,LTD

PART NO: P2000R-12XXXXXXXXXXXXX1

TITLE : 2.00MM 双排针 90°

# ROHS REACH

日期版次 REVISION	日期 DATE	变更内容 DESCRIPTION	核准 APPROVAL

### SPECIFICATIONS

备注 (Remark)

1. 材料 (MATERIAL)

胶芯: PA6T+30%G.F UL94V-0, 颜色: 黑色

Housing: PA6T+30%G.F UL94V-0, Color: Black

四方针: 黄铜, 镍底30U"MIN, 表面镀金0.8U"MIN

Contact: Brass, 0.8u"min Gold Plating Over All  
30u"min Nickel Underplating Over All

2. 特性 (characteristics):

额定电流: 2.0 AMP

Raring Current: 2.0 AMP

接触阻抗: 20MΩ MAX

Contact Resistance: 20mΩ Max

绝缘阻抗: 1000MΩ MIN

Insulation Resistance: 1000MΩ Min

耐电压: AC 500V

Withstand Voltage: 500V AC/DC

温度范围: -40°C to +105°C

Operation Temperature: -40°C to +105°C

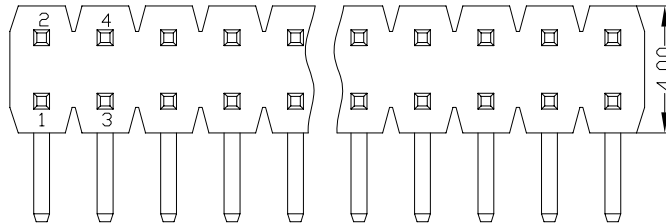

## Ordering Information

P2000R-22 XX XX X XX XXX X 1

No. of Pins Per Row 2-40	Contact Plating Full of Glod A0=0.8U' A1=1U' A2=1.5U' A3=2U' A4=3U' A5=5U' A6=10U' A7=15U' A8=20U' A9=30U'	Semi-gold B0=0.8U' B1=1U' B2=1.5U' B3=2U' B4=3U' B5=5U' B10=10U' B15=15U' B20=20U' B30=30U'	Insulatot Material: B=BK-PA6T C=BK-PA9T D=BK-LCP	HEIGHT OF HOUSING 101.0mm 151.5mm 202.0mm	Length of Terminal	Packing A=PE Bag T=Tape&Reel C=Tube D=Tube+Cap E=Tray
	S1=Ordinary Tin Plated S2=Matte Tin Plated S3=Tin-platde High-temperature					

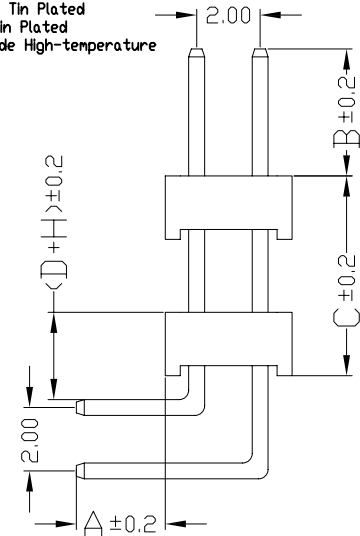
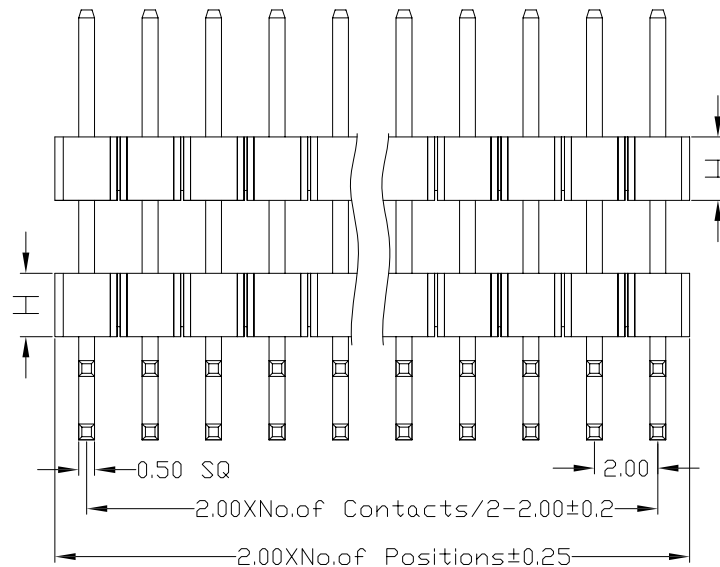
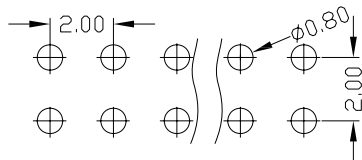

Dimension antitheses list

ITEM	D	A	B	H	C
Standard	0	1.2	1.8	3	4
Alternate	0.8	1	1.5		

REV: A	APPROVE	CHECK	DRAWN	MATERIAL:	GENERAL TOLERANCE	
SHEET:1/1	FENG	ZENG	LIJIAN	UNIT: MM	X. ±0.30	X.* ±2*
				SCALE: 3:1	X.X ±0.25	X.X* ±1*
				SIZE: A4	X.XX ±0.15	

**YSTZ** 东莞市轩盟电子科技有限公司  
DONGGUAN YSTZ ELECTRONIC TECHNOLOGY CO.,LTD

PART NO: P2000R-22XXXXXXXXXXXXX1

TITLE : 2.00MM 双排针 双塑 90